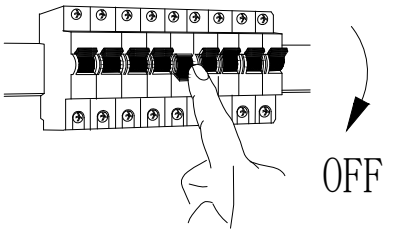
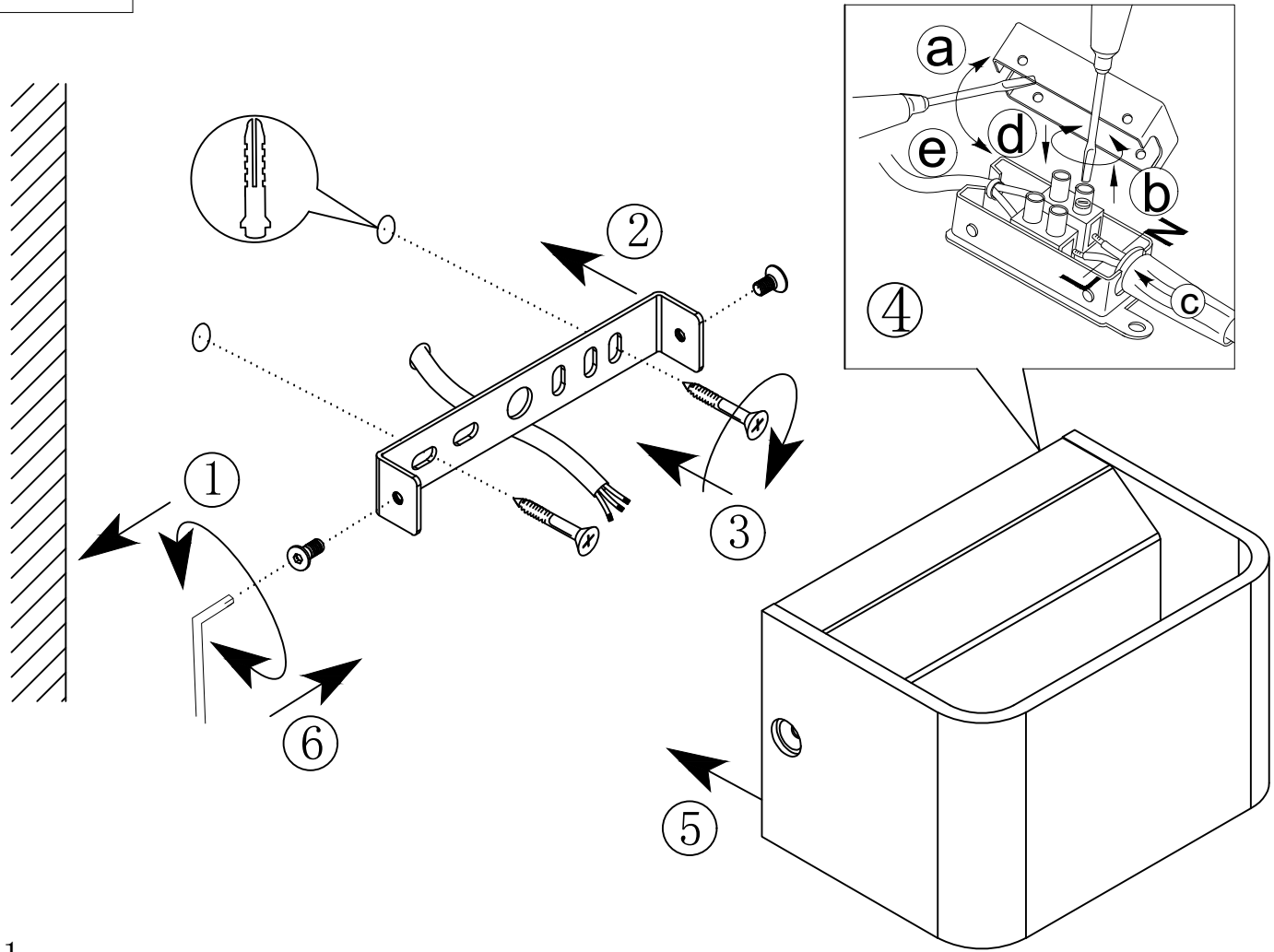
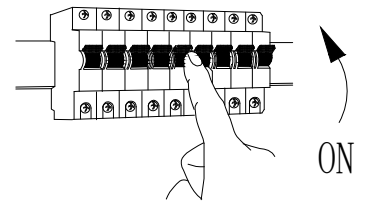

**A****B****C**

BLA98421  
www.eglo.com